

# Serviprinter

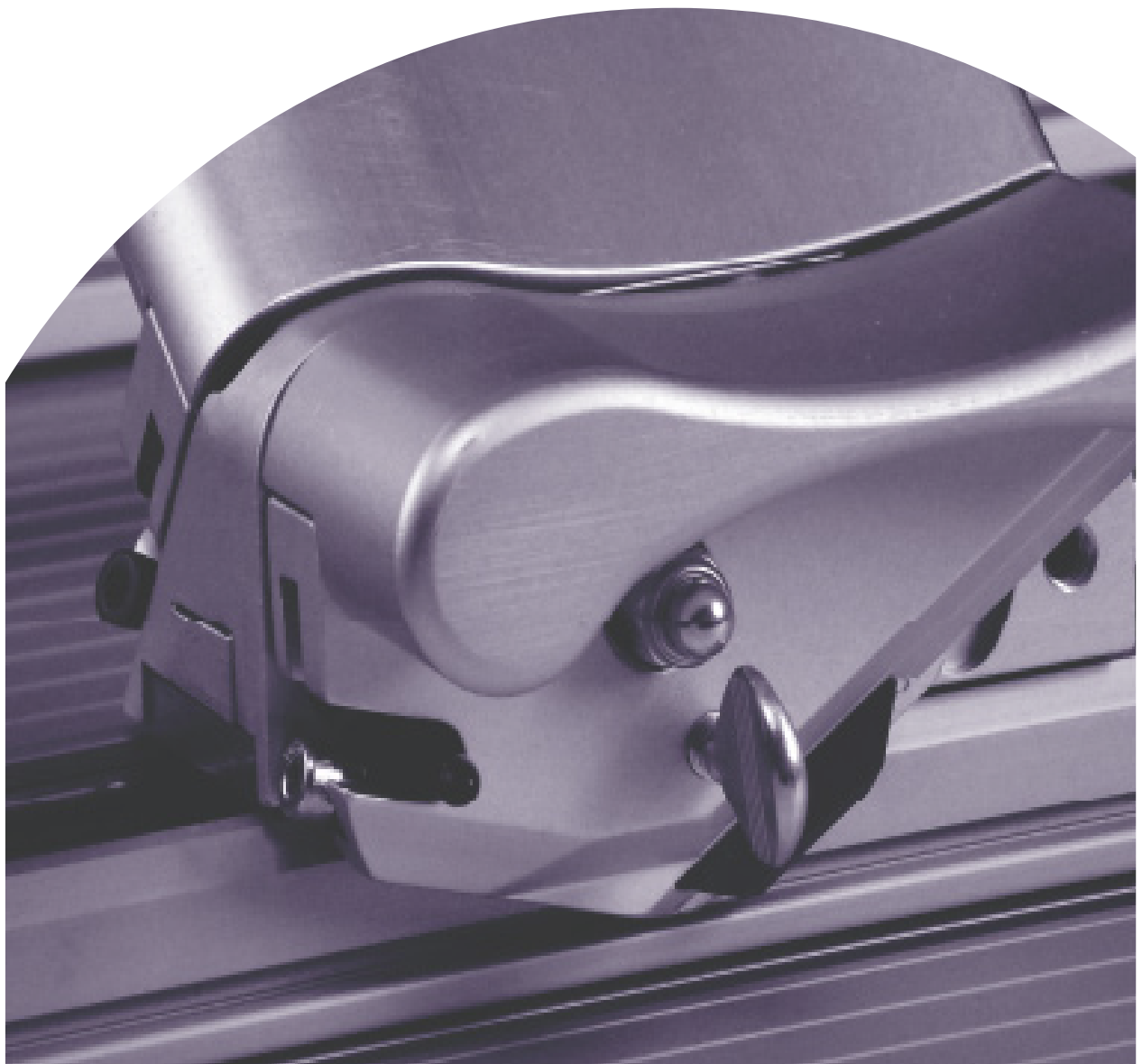

Dinos cuando quieres venir al:

De 10:00 a 12:30  
Promoción y plazas limitadas



Tef.- 954.29.40.44  
correo [serviprinter@serviprinter.es](mailto:serviprinter@serviprinter.es)  
WhatsApp 657.55.25.94



## Serviprinter



P.I. Store Calle Gramil nº 6 41008 Sevilla Tel.- 954.29.40.44 [serviprinter@serviprinter.es](mailto:serviprinter@serviprinter.es)

## KEENCUT EVOLUTION E3

### Evolution E3 - Smartfold

- Barra de corte manual



Cabezal Graphik incluido

Modelo Keencut	Medida	PVP
Evolution 3 -Smartfold 1.1m	110 cm	1.432€
Evolution 3 -Smartfold 1.6m	160 cm	1.571€
Evolution 3 -Smartfold 2.1m	210 cm	1.740€
Evolution 3 -Smartfold 2.6m	260 cm	2.053€
Evolution 3 -Smartfold 3.1m	310 cm	2.324€
Evolution 3 -Smartfold 3.6m	360 cm	2.819€

### IDEAL PARA CORTAR

<p><b>Materiales Rígidos</b>                      Acrílico fundido / Plexiglas ≤ 3 mm (3/32") (Sólo marcar)                      Panel aluminio composite ≤ 3 mm (3/32")(Rocker tool)</p> <p><b>Materiales Semi-Rígidos</b>                      Tablero de espuma de PVC ≤ 13 mm (1/2")                      Plástico corrugado/escaldado ≤ 13 mm (1/2")                      Foam Board ≤ 13 mm (1/2")</p>	<p><b>Materiales flexibles</b>                      Banners                      Pop-ups                      Láminas magnéticas                      Película                      Vinilos autoadhesivos                      Textiles y materiales delicados                      Papel paredes</p>
--	---

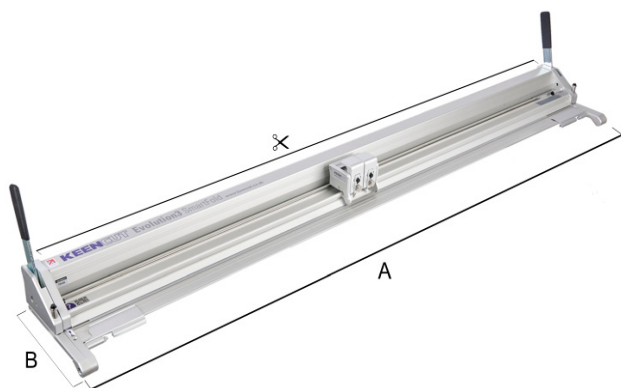

	E3SF110	E3SF160	E3SF210	E3SF260	E3SF310
✂ Cut Length cm	110	160	210	260	310
A cm	148	198	248	298	348
B cm	27	27	27	27	27
Packed Weight KG	30	37.5	46.5	53.5	63
Packed Dimensions cm	160x35x17	210x35x17	260x35x17	310x35x17	360x35x17

	E3SF360	E3SF410	E3SF460	E3SF510
✂ Cut Length cm	360	410	460	510
A cm	398	448	498	548
B cm	27	27	27	27
Packed Weight KG	71.5	82	90	99
Packed Dimensions cm	410x35x17	462x38x32	513x38x32	564x38x32

## Evolution E3 - BenchTop

- Barra de corte manual



Cabezal Graphik incluido

Modelo Keencut	Medida	PVP
Evolution 3 -BenchTop 1.1m	110 cm	1.191€
Evolution 3 -BenchTop 1.6m	160 cm	1.322€
Evolution 3 -BenchTop 2.1m	210 cm	1.471€
Evolution 3 -BenchTop 2.6m	260 cm	1.738€
Evolution 3 -BenchTop 3.1m	310 cm	1.959€
Evolution 3 -BenchTop 3.6m	360 cm	2.365€

### IDEAL PARA CORTAR

<p><b>Materiales Rígidos</b>                      Acrílico fundido / Plexiglas ≤ 3 mm (3/32") (Sólo marcar)                      Panel aluminio composite ≤ 3 mm (3/32")(Rocker tool)</p> <p><b>Materiales Semi-Rígidos</b>                      Tablero de espuma de PVC ≤ 13 mm (1/2")                      Plástico corrugado/escaldado ≤ 13 mm (1/2")                      Foam Board ≤ 13 mm (1/2")</p>	<p><b>Materiales flexibles</b>                      Banners                      Pop-ups                      Láminas magnéticas                      Película                      Vinilos autoadhesivos                      Textiles y materiales delicados                      Papel paredes</p>
--	---

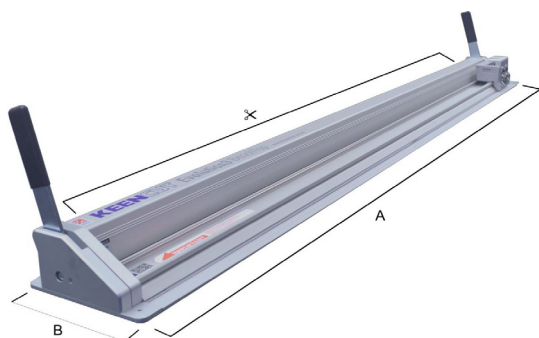

	E3BT110	E3BT160	E3BT210	E3BT260	E3BT310
✂ Cut Length cm	110	160	210	260	310
A cm	148	198	248	298	348
B cm	20.5	20.5	20.5	20.5	20.5
Packed Weight KG	27	34.5	42	50	56
Packed Dimensions cm	160x35x17	210x35x17	260x35x17	310x35x17	360x35x17

	E3BT360	E3BT410	E3BT460	E3BT510
✂ Cut Length cm	360	410	460	510 (201)
A cm	398	448	498	548 (216)
B cm	20.5	20.5	20.5	20.5 (8)
Packed Weight KG	62.5	72	79	86 (189.5)
Packed Dimensions cm	410x35x17	462x38x32	513x38x32	564x38x32 (222x15x13)

## Evolution E3 - FreeHand

Barra de corte manual



Cabezal Graphik incluido

Modelo Keencut	Medida	PVP
Evolution 3 -FreeHand 1.1m	110 cm	824€
Evolution 3 -FreeHand 1.6m	160 cm	912€
Evolution 3 -FreeHand 2.1m	210 cm	997€
Evolution 3 -FreeHand 2.6m	260 cm	1.098€
Evolution 3 -FreeHand 3.1m	310 cm	1.224€

### IDEAL PARA CORTAR

<p><b>Materiales Rígidos</b> Acrílico fundido / Plexiglas ≤ 3 mm (3/32") (Sólo marcar)</p> <p><b>Materiales Semi-Rígidos</b> Tablero de espuma de PVC ≤ 13 mm (1/2") Plástico corrugado/escaldado ≤ 13 mm (1/2") Foam Board ≤ 13 mm (1/2")</p>	<p><b>Materiales flexibles</b> Banners Pop-ups Láminas magnéticas Película Vinilos autoadhesivos</p>
--	--

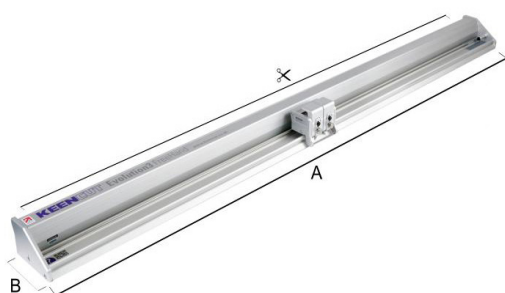





	E3FH110	E3FH160	E3FH210	E3FH260	E3FH310
Cut Length cm	110	160	210	260	310
A cm	148	198	248	298	348
B cm	15.5	15.5	15.5	15.5	15.5
Packed Weight KG	22	28	34	40	46
Packed Dimensions cm	154x35x17	204x35x17	254x35x17	304x35x17	354x35x17

## KEENCUT EVOLUTION E3 CABEZALES ADICIONALES

### Evolution E3 - Cabezales adicionales



Modelo Keencut		PVP
Cabezal Corte Graphic Doble		223€
Cabezal Corte Fabric		287€
Cabezal Corte Creaser		223€
Cabezal Corte Rocker		223€

HERRAMIENTA	CARACTERISTICA	IDEAL PARA
	<b>DOBLE GRAPHIK</b> Corte bidireccional con dos portacuchillas individuales. Las cuchillas Graphik son mas fuertes y mas estables.	Vinilo, pancarta, cartón, espuma de PVC de hasta 13mm, tablero centrado en espuma, plástico y papel corrugado, materiales desplegables y enrollables
	<b>FABRIC</b> Rueda de corte con resorte. Presión constante para un corte confiable. Corte en ambas direcciones.	Tela, papel, películas, vinilo, pancartas, materiales delicados.
	<b>CREASER</b> Para hacer hendidos	Papel robusto y cartulina, cartón, tablero gris.
	<b>ROCKER</b> Rueda de corte con resorte. Presión constante para un corte confiable. Corte en ambas direcciones.	Cartón, espumas hasta 10mm. También para cortar aluminio composite, como Di-boind o Alupanel hasta 3mm.

### Evolution E3 - Consumibles

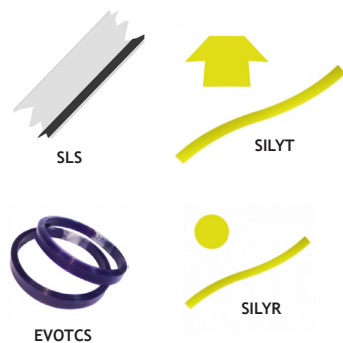

	Referencia	PVP
Recambio cinta para corte textil	EVOTCS	81,70€
Keencut Graphik blades	CA50-032	65,10€
Keencut 45mm circular blades (x10)	CIR45	129,00€
Reemplazo cinta plástico de visión	SLS	46,50€
Yellow "T" shape silicone cord 10m	SILYT	32,40€
Yellow round shape silicone cord 10m	SILYR	32,40€
Cuchilla Keencut Tech D.012 (x100)	CA50-017	61,90€
Cuchilla superior 080 (x100)	CA50-010	61,90€
Medium duty blades (x100)	CA50-019	31,60€



## KEENCUT STELTRAK

### Evolution E3 - Steeltrak

■ Barra de corte vertical

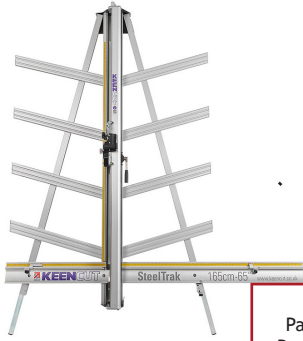

Modelo Steeltrak	Medida	PVP
Keencut Steeltrak ST165	165 cm	3.967€
Keencut Steeltrak ST210	210 cm	4.609€
Keencut Steeltrak ST250	250 cm	5.570€

#### IDEAL PARA CORTAR

##### Materiales Rígidos

Panel compuesto de aluminio, p. Ej., Dibond  $\leq 4$  mm (1/8 ")  
 Panel compuesto de acero, p. Ej., Multishield  $\leq 3$  mm (3/32 ")  
 V Dibond  $\leq 3$  mm (3/32 ") con ranura en V SteelTrak opcional  
 MDF  $\leq 3$  mm (3/32 ")  
 Acrílico fundido/ plexiglás (solo rayado)  $\leq 3$  mm (3/32 ")  
 Vidrio  $\leq 6$  mm (1/4 ") con kit de corte de vidrio opcional (STGLC)

##### Materiales Semi-Rígidos

Panel compuesto de aluminio, p. Ej., Dibond  $\leq 4$  mm (1/8 ")  
 Plástico corrugado / estriado  $\leq 13$  mm (1/2 ")  
 Cartón corrugado  $\leq 13$  mm (1/2 ")  
 Tablero con centro de espuma  $\leq 13$  mm (1/2 ")  
 Tablero de montaje  $\leq 6$  mm (1/4 ")  
 Lámina de aluminio  $\leq 1$  mm (1/25 ") con cabezal de corte (STALC)



V-Groover



STALW



CA50-015



STVGB



FSK160/210/250

Accesorios Steetrak	Referencia	PVP
Extensión brazo izquierdo	STSAE	213€
Kit de soporte individual ST165	FSK160	267€
Kit de soporte individual ST210	FSK210	379€
Kit de soporte individual ST250	FSK250	696€
Kit corte de cristal (corte max.165cm)	STGLC	187€
Reemplazo juego de ruedas aluminio	STALW	80,60€
Rueda de corte para cristal TC(5u.)	CA50-015	96€
Cabezal de corte acero o aluminio	STC2C	187€
Cabezal de corte acero 1mm	STSTC	158€
90° V-Groover 2mm	STVG2	212€
90° V-Groover 3mm	STVG3	212€
90° V-Groover 4mm	STVG4	212€
90° V-Groover 6mm	STVG5	212€
90° V-Groover 6mm	STVG6	212€
V-Groover cuchillas (5u.)	STVGB	251€
Reemplazo cinta plástico de visión	SLS	46,50€
Cuchillas medium duty (100u.)	CA50-019	31,60€
Reemplazo juego de ruedas aluminio	STCOW	94,60€

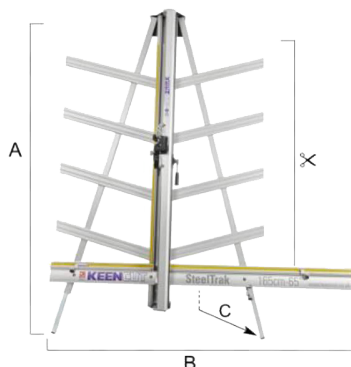

	ST165	ST210	ST250
Cut Length	165cm (65")	210cm (82")	250cm (98")
A Min/Max	226-264cm	271-309cm	310-348cm
B	213cm	213cm	222cm
Wall Mounted-Standard	52-58cm	67-73cm	75-78cm
Free Standing-Optional	100cm	100cm	123cm
Packed Weight	75kg	94kg	110kg
Packed Dimensions	1 Box Only 233x46x35cm	1 Box Only 280x46x35cm	2 Boxes Box1: 328x27x36cm Box 2: 264x17x16cm

## Evolution E3 - Excalibur 3S

■ Barra de corte vertical



Modelo Steeltrak	Medida	PVP
Keencut Excalibur 3S	160 cm	3.369€

### IDEAL PARA CORTAR

#### Materiales Rígidos

Panel compuesto de aluminio, p. Ej., Dibond  $\leq 3$  mm (3/32")  
MDF  $\leq 3$  mm ( 3/32 ")  
Acrílico fundido / plexiglás (solo rayado)  $\leq 3$  mm (3/32 ")

#### Materiales Semi-Rígidos

Plástico corrugado / estriado  $\leq 13$  mm (1/2 ")  
Cartón corrugado  $\leq 13$  mm (1/2 ")  
Tablero de espuma de PVC  $\leq 13$  mm (1/2 ")  
Foam Board  $\leq 13$  mm (1/2")  
Hoja magnética  $\leq 4$  mm (1/8")



FSK160



EXCOC

Accesorios Exalibur 3S	Referencia	PVP
Kit de soporte individual EX160	FSK160	267€
Recambio cabezal de corte TW	EXCOC	133€
Reemplazo cinta plástico de visión	SLS	46,50€
Cuchillas medium duty (100u.)	CA50-019	31,60€
Reemplazo juego de ruedas aluminio	EXCOW	73,20€

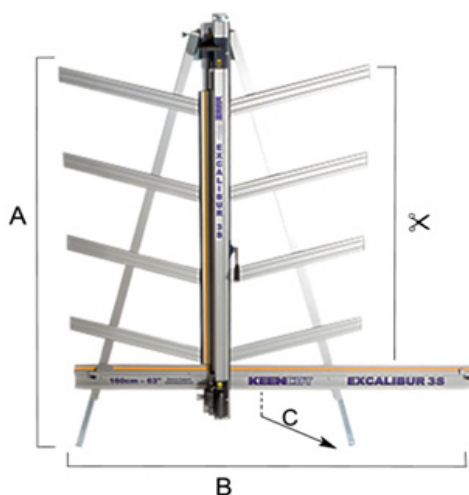

	EX3S165
✂ Cut Length cm	160
A cm	244
B cm	213
Wall Mounted - Standard - C cm	30-40
Free-standing - Optional - C cm	80-90
Packed Weight KG	67
Packed Dimensions cm	231x40x30

## KEENCUT SABRE SERIE 2

### Sabre Series 2

- Barra de corte manual



- No incluye soporte con bolsa

Keencut SABRE2	Medida	PVP
Sabre Serie 2 - 1.0m 40"	100 cm	960€
Sabre Serie 2 - 1.5m 60"	150 cm	1.124€
Sabre Serie 2 - 2.0m 80"	200 cm	1.289€
Sabre Serie 2 - 2.5m 100"	250 cm	1.450€
Sabre Serie 2 - 3.0m 120"	310 cm	1.616€



Soporte con bolsa

Opcionales Sabre 2	Medida	PVP
Soporte con bolsa Sabre Serie 2 - 1.0m 40"	100 cm	907€
Soporte con bolsa Sabre Serie 2 - 1.5m 60"	150 cm	1.016€
Soporte con bolsa Sabre Serie 2 - 2.0m 80"	200 cm	1.142€
Soporte con bolsa Sabre Serie 2 - 2.5m 100"	250 cm	1.271€
Soporte con bolsa Sabre Serie 2 - 3.0m 120"	300 cm	1.386€

### IDEAL PARA CORTAR

Materiales Rígidos	Materiales flexibles
Acrílico fundido $\leq 3$ mm (3/32") (Solo marcar)	Banners
<b>Materiales Semi-Rígidos</b>	Pop-ups
Tablero de espuma de PVC $\leq 13$ mm (1/2")	Láminas magnéticas
Plástico corrugado/escaldado $\leq 13$ mm (1/2")	Película
Cartón corrugado $\leq 13$ mm (1/2")	Vinilos autoadhesivos
Foam Board $\leq 13$ mm (1/2")	Textiles y materiales delicados
Hoja magnética $\leq 4$ mm (1/8")	



SILWR

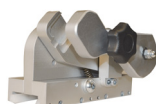

HOT



SABEMA



TEXC

Accesorios Sabre 2	Referencia	PVP
White round shape silicone cord 10m	SILWR	99,20€
Extensión brazo de medición 1m	SABEMA	115€
Yellow silicone grip cord "T" 10m	SILYT	32,40€
Medium Duty Blades (x100)	CA50-019	31,60€
Graphik blades (x100)	CA50-032	65,10€
Cuchilla circular Textile (x10)	CIR45	129€
HSGM soporte para corte textil caliente	HOT	174€
28mm. Textile cutting tool	TEXC	51,80€
28mm. Circular textile blades (x10)	TEXB	102,10€



	SAB100	SAB150	SAB200	SAB250	SAB300
✂ Cut Length cm (")	100 (40)	150 (60)	200 (80)	250 (100)	300 (120)
A cm (")	118 (46.5)	168 (66)	218 (85.75)	268 (105.5)	318 (125)
B cm (")	33 (13)	33 (13)	33 (13)	33 (13)	33 (13)
Packed Weight KG (lbs)	13 (29)	15 (33)	35 (77)	41 (90)	49 (108)
Packed Dimensions cm (")	132x40x19 (52x16x8)	168x40x19 (66x16x8)	228x40x19 (90x16x8)	280x40x19 (111x16x8)	326x40x19 (129x16x8)



## KEENCUT SIMPLEX

### Keencut Simplex

- Barra de corte manual



Keencut SIMPLEX	Medida	PVP
SIMPLEX - 1.1m	110 cm	519€
SIMPLEX - 1.6m	160 cm	575€
SIMPLEX - 2.1m	210 cm	626€
SIMPLEX - 2.6m	260 cm	690€
SIMPLEX - 3.1m	310 cm	772€

### IDEAL PARA CORTAR

Materiales Semi-Rígidos	Materiales flexibles
FoamBoard de PVC ≤ 6 mm (1/4")	Banners
Plástico corrugado/escaldado ≤ 10 mm (3/8")	Pop-ups
Cartón corrugado ≤ 10 mm (3/8")	Láminas magnéticas
FoamBoard ≤ 10 mm (3/8")	Película
	Vinilos autoadhesivos
	Textiles y materiales delicados



Accesorios Simplex	Referencia	PVP
Yellow silicone grip cord "T" 10m	SILYT	32,40€
Medium Duty Blades (x100)	CA50-019	31,60€
Cuchilla circular Textile (x10)	CIR45	102,10€
28mm textile cutting tool	TEXC	51,80€



	SIM110	SIM160	SIM210	SIM260	SIM310
✂ Cut Length cm	110	160	210	260	310
A cm	127	177	227	277	327
B cm	11	11	11	11	11
Packed Weight KG	4	6	7	21	26
Packed Dimensions cm	173x19x9	190x17x16	237x17x16	289x20x17	338x20x17

## KEENCUT TECHNIC

### Keencut Technic ARC

- Barra de corte manual giratorio



Keencut TECHNIC ARC	Medida	PVP
TECHNIC ARC - 1.0m 40"	107 cm	692€
TECHNIC ARC - 1.5m 60"	152 cm	828€
TECHNIC ARC - 2.0m 80"	203 cm	976€
TECHNIC ARC - 2.5m 100"	254 cm	1.133€
TECHNIC ARC - 3.0m 120"	305 cm	1.263€

- No incluye soporte con bolsa ni rodillo



Soporte con bolsa y rodillo

Opcionales TECHNIC ARC	Medida	PVP
Soporte con bolsa y rodillo Technic ARC 107	107 cm	949€
Soporte con bolsa y rodillo Technic ARC 152	152 cm	1.073€
Soporte con bolsa y rodillo Technic ARC 203	203 cm	1.142€
Soporte con bolsa y rodillo Technic ARC 254	254 cm	1.271€
Soporte con bolsa y rodillo Technic ARC 305	305 cm	1.386€

### IDEAL PARA CORTAR

<b>Materiales Semi-Rígidos</b> Cartón ≤ 1 mm (0,04") Tablero de montaje ≤ 1 mm (0,04")	<b>Materiales flexibles</b> Banners Pop-ups Láminas magnéticas Película Vinilos autoadhesivos
--	--



ARCCH



RCMA

Accesorios Technic ARC	Referencia	PVP
Brazo mediación extendido T. ARC 36"	RCMA	101,30€
Recambio cabezal corte Technic	ARCCH	132€

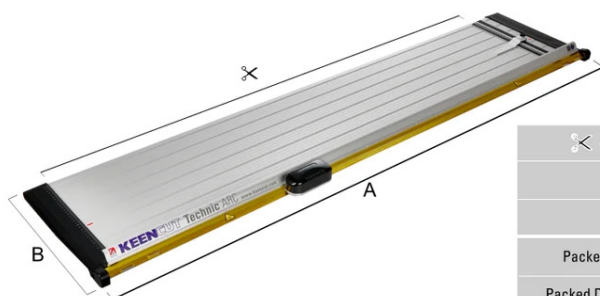

	ARC107	ARC152	ARC203	ARC254	ARC305
✂ Cut Length cm	106	152	203	254	305
A cm	133	179	231	280	332
B cm	43.5	43.5	43.5	43.5	43.5
Packed Weight KG	11	14	18	22	25
Packed Dimensions cm	145x20x11	191x50x11	243x50x11	292x50x11	342x50x11

## Keencut Technic ARC TE

■ Barra de corte manual giratorio

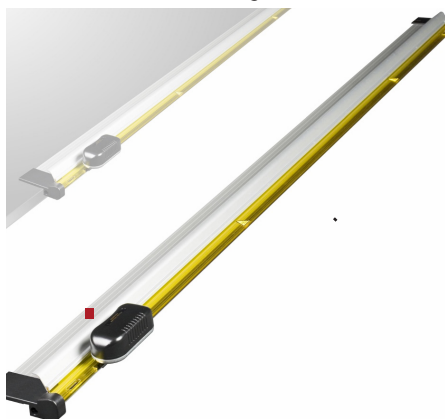

Keencut TECHNIC ARC TE	Medida	PVP
TECHNIC ARC - 1.0m 40"	100 cm	459€
TECHNIC ARC - 1.5m 60"	150 cm	520€
TECHNIC ARC - 2.0m 80"	200 cm	577€
TECHNIC ARC - 2.5m 100"	250 cm	746€
TECHNIC ARC - 3.0m 120"	300 cm	774€

### IDEAL PARA CORTAR

Materiales Semi-Rígidos	Materiales flexibles
Cartón ≤ 1 mm (0,04") Tablero de montaje ≤ 1 mm (0,04")	Papel Película Vinilos autoadhesivos



ARCCH



RCMA

Accesorios Technic ARC TE	Referencia	PVP
Brazo mediación extendido T. ARC 36"	RCMA	101,30€
Recambio cabezal corte Technic	ARCCH	132€

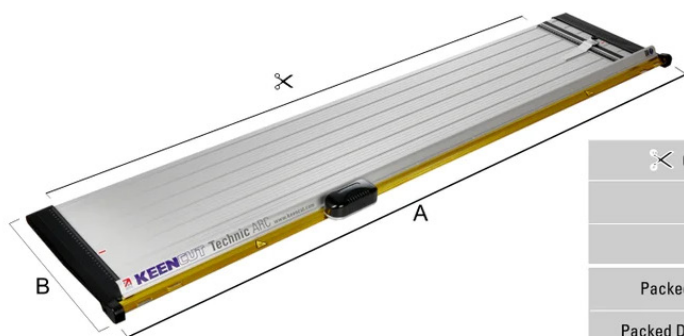

	ARC107	ARC152	ARC203	ARC254	ARC305
✂ Cut Length cm	106	152	203	254	305
A cm	133	179	231	280	332
B cm	43.5	43.5	43.5	43.5	43.5
Packed Weight KG	11	14	18	22	25
Packed Dimensions cm	145x20x11	191x50x11	243x50x11	292x50x11	342x50x11

## KEENCUT SAFETY STRAIGHT EDGE

### Keencut Reglas de seguridad

■ Reglas de corte manual

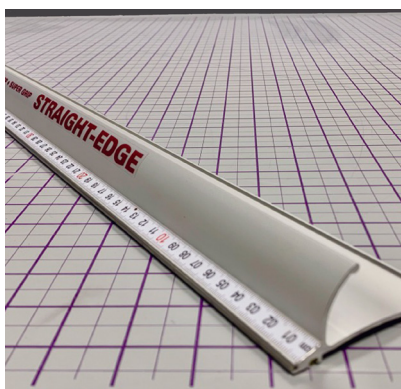

Keencut Safety Straight Edge	Medida	PVP
Regla seguridad 45	45 cm	65,90€
Regla seguridad 60	60 cm	71,40€
Regla seguridad 75	75 cm	78,60€
Regla seguridad 90	90 cm	87,80€
Regla seguridad 105	105 cm	93,30€
Regla seguridad 120	120 cm	98,90€
Regla seguridad 135	135 cm	104€
Regla seguridad 150	150 cm	112€
Regla seguridad 180	180 cm	130€



	MS45	MS60	MS75	MS90	MS105	MS120	MS135	MS150	MS180
Overall Length (cm)	45	60	75	90	105	120	135	150	180
Packed Weight KG	0.7	0.9	1	1.2	1.5	1.6	1.9	2	2.4

## KEENCUT BENCHTOP

### Keencut Evolution 3 Smartfold benches

■ Mesa de corte

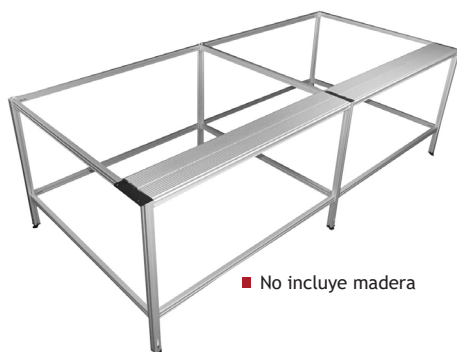

Keencut Smartfold benches	Referencia	PVP
Evolution3 Smartfold 110	SFB110	1.214€
Evolution3 Smartfold 160	SFB160	1.332€
Evolution3 Smartfold 210	SFB210	1.476€
Evolution3 Smartfold 260	SFB260	1.741€
Evolution3 Smartfold 310	SFB310	1.970€
Evolution3 Smartfold 360	SFB360	2.390€

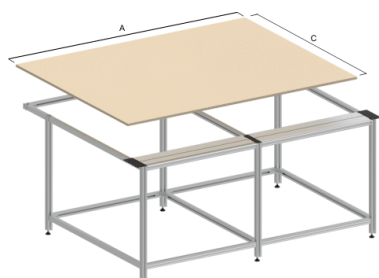

Medidas madera Smartfold	A cm X C cm	PVP
Evolution3 Smartfold 110	1440mm x 1220mm	NO SE VENDE
Evolution3 Smartfold 160	1940mm x 1220mm	NO SE VENDE
Evolution3 Smartfold 210	2440mm x 1220mm	NO SE VENDE

**LA MADERA NO LA VENDE STANDKOLOR**

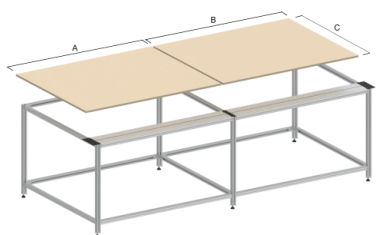

Medidas madera Smartfold	A cm X B cm X C cm	PVP
Evolution3 Smartfold 260	1470mm x 1470mm x 1220mm	NO SE VENDE
Evolution3 Smartfold 310	1160mm x 2280mm x 1220mm	NO SE VENDE
Evolution3 Smartfold 360	1327mm x 1287mm x 1220mm	NO SE VENDE

**LA MADERA NO LA VENDE STANDKOLOR**

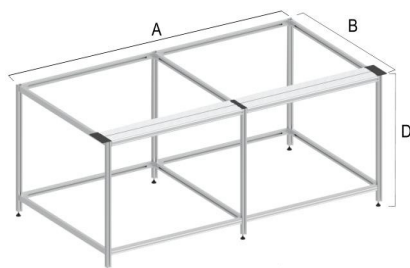

Bench dimensions	SFB110	SFB160	SFB210	SFB260	SFB310	SFB360
A cm	140	190	240	290	340	390
B cm	133	133	133	133	133	133
D cm	90	90	90	90	90	90

Packed weights & dimensions	SFB110	SFB160	SFB210	SFB260	SFB310	SFB360
Packed weight KG	29	41.5	46	50	63	68
Packed dimensions cm	1 box only: Box 1: 192x25x13	2 boxes: Box 1: 141x25x13 Box 2: 105x25x13	2 boxes: Box 1: 140x25x13 Box 2: 118x25x13	2 boxes: Box 1: 140x25x13 Box 2: 143x25x13	3 boxes: Box 1: 180x25x13 Box 2: 112x25x13 Box 3: 124x25x13	3 boxes: Box 1: 180x25x13 Box 2: 129x25x13 Box 3: 140x25x13

## Keencut Evolution 3 Benchtop benches



Keencut Benchtop benches	Referencia	PVP
Evolution3 Benchtop 110	BTB110	1.015€
Evolution3 Benchtop 160	BTB160	1.127€
Evolution3 Benchtop 210	BTB210	1.254€
Evolution3 Benchtop 260	BTB260	1.481€
Evolution3 Benchtop 310	BTB310	1.670€
Evolution3 Benchtop 360	BTB360	2.016€

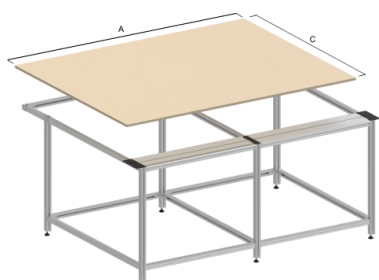

Medidas madera Benchtop	A cm X C cm	PVP
Evolution3 Benchtop 110	1520mm x 1220mm	NO SE VENDE
Evolution3 Benchtop 160	2020mm x 1220mm	NO SE VENDE

**LA MADERA NO LA VENDE STANDKOLOR**

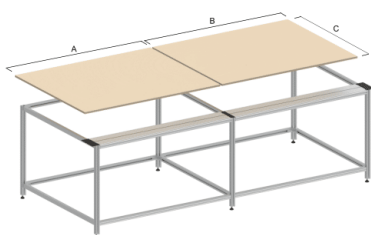

Medidas madera Benchtop	A cm X B cm X C cm	PVP
Evolution3 Benchtop 210	1260mm x 1260mm x 1220mm	NO SE VENDE
Evolution3 Benchtop 260	1510mm x 1510mm x 1220mm	NO SE VENDE
Evolution3 Benchtop 310	1187mm x 2334mm x 1220mm	NO SE VENDE
Evolution3 Benchtop 360	1353mm x 1313mm x 1220mm	NO SE VENDE

**LA MADERA NO LA VENDE STANDKOLOR**

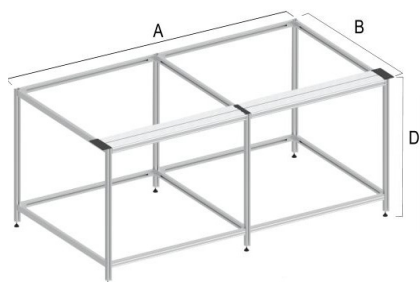

Bench dimensions	BTB110	BTB160	BTB210	BTB260	BTB310	BTB360
A cm	148	198	248	298	348	398
B cm	122	122	122	122	122	122
D cm	90	90	90	90	90	90

Packed weights & dimensions	BTB110	BTB160	BTB210	BTB260	BTB310	BTB360
Packed weight KG (lbs)	23	32	35	37	47	50
Packed dimensions cm	1 box only: Box 1: 178x25x13	2 boxes: Box 1: 117x25x13 Box 2: 92x25x13	2 boxes: Box 1: 125x25x13 Box 2: 92x25x13	2 boxes: Box 1: 149x25x13 Box 2: 92x25x13	2 boxes: Box 1: 119x25x13 Box 2: 141x25x13	2 boxes: Box 1: 132x25x13 Box 2: 157x25x13

standKOLOR®		Medium duty	Graphik	080 Superior quality	45mm circular	Tech D 0.12	28mm circular	Acrylic scoring	Cutting wheels	V-groove	Glass cutting wheels
Vertical cutters	SteelTrak	Yes	CA50-032	CA50-010	CIR45	CA50-017	TEXB	SCO	STCOW or EXCOW	STVGB	CA50-015
	Excalibur 3S	Yes		Yes					Yes (STCOW in 'C' or 'C2' head) Yes (EXCOW)	Yes (in V-groove head)	Yes (with glass cutting kit)
Cutter bars	Evolution3 range	Yes (rocker head)	Yes (graphik head)	Yes (rocker head)	Yes (fabric head)	Yes (rocker head)					
	Sabre S2	Yes (med duty blade holder)	Yes (graphik blade holder)	Yes (med duty blade holder)	Yes (fabric blade holder)						
	Simplex	Yes		Yes			Yes (in textile attachment)	Yes			
Discontinued machines	Evolution E2, Javelin Integra & Javelin S2	Yes (med duty blade holder)	Yes (graphik blade holder)	Yes (med duty blade holder)	Yes (fabric blade holder)						
	Original Evolution, Sabre, Javelin 1, Praktik and Max	Yes		Yes			Yes (in textile attachment)				
	Excalibur 1000, 1000X and 3000	Yes		Yes					Yes (EXCOW unless black plate then EXCOC)		Yes
	System 4000	Yes		Yes							

## KEENCUT CONSUMIBLES

### Keencut Cuchillas



Referencia	DESCRIPCIÓN	Euros
CA50-032	Keencut Graphik blades (x100)	65,10€



Referencia	DESCRIPCIÓN	Euros
CIR 45	Olfa 45mm Circular textil	129€



Referencia	DESCRIPCIÓN	Euros
CA50-010	Superior quality 080 blades (x100)	61,90€



Referencia	DESCRIPCIÓN	Euros
CA50-019	Medium Duty Blades (x100)	31,60€



Referencia	DESCRIPCIÓN	Euros
TEXB	28mm Circular textile blades (x10)	102,10€



Referencia	DESCRIPCIÓN	Euros
CA50-015	Tungsten Glass Cutting wheel (x5)	95,00€



Referencia	DESCRIPCIÓN	Euros
STALW	Aluminium twin wheel cutter	80,60€



Referencia	DESCRIPCIÓN	Euros
CA50-017	Tech D .012 (x100)	61,90€



Referencia	DESCRIPCIÓN	Euros
STCOW	Composite twin wheel cutter	94,60€



Referencia	DESCRIPCIÓN	Euros
STVGB	V-Groove Replace Blade (x5)	251,00€



## Keencut Accesorios

	<table border="1"> <thead> <tr> <th>Referencia</th> <th>DESCRIPCIÓN</th> <th>Euros</th> </tr> </thead> <tbody> <tr> <td>STC2C</td> <td>Steel and aluminium composite head</td> <td>187€</td> </tr> </tbody> </table>	Referencia	DESCRIPCIÓN	Euros	STC2C	Steel and aluminium composite head	187€
Referencia	DESCRIPCIÓN	Euros					
STC2C	Steel and aluminium composite head	187€					
	<table border="1"> <thead> <tr> <th>Referencia</th> <th>DESCRIPCIÓN</th> <th>Euros</th> </tr> </thead> <tbody> <tr> <td>STSTC</td> <td>Steel plate cutting head</td> <td>158€</td> </tr> </tbody> </table>	Referencia	DESCRIPCIÓN	Euros	STSTC	Steel plate cutting head	158€
Referencia	DESCRIPCIÓN	Euros					
STSTC	Steel plate cutting head	158€					
	<table border="1"> <thead> <tr> <th>Referencia</th> <th>DESCRIPCIÓN</th> <th>Euros</th> </tr> </thead> <tbody> <tr> <td>SLS</td> <td>Sightline Strips 5m</td> <td>46,50€</td> </tr> </tbody> </table>	Referencia	DESCRIPCIÓN	Euros	SLS	Sightline Strips 5m	46,50€
Referencia	DESCRIPCIÓN	Euros					
SLS	Sightline Strips 5m	46,50€					
	<table border="1"> <thead> <tr> <th>Referencia</th> <th>DESCRIPCIÓN</th> <th>Euros</th> </tr> </thead> <tbody> <tr> <td>SILYT</td> <td>Yellow "T" Silicone cord (10m)</td> <td>32,40€</td> </tr> </tbody> </table>	Referencia	DESCRIPCIÓN	Euros	SILYT	Yellow "T" Silicone cord (10m)	32,40€
Referencia	DESCRIPCIÓN	Euros					
SILYT	Yellow "T" Silicone cord (10m)	32,40€					
	<table border="1"> <thead> <tr> <th>Referencia</th> <th>DESCRIPCIÓN</th> <th>Euros</th> </tr> </thead> <tbody> <tr> <td>SILYR</td> <td>Yellow round shape silicone (10m)</td> <td>32,40€</td> </tr> </tbody> </table>	Referencia	DESCRIPCIÓN	Euros	SILYR	Yellow round shape silicone (10m)	32,40€
Referencia	DESCRIPCIÓN	Euros					
SILYR	Yellow round shape silicone (10m)	32,40€					
	<table border="1"> <thead> <tr> <th>Referencia</th> <th>DESCRIPCIÓN</th> <th>Euros</th> </tr> </thead> <tbody> <tr> <td>ARCCH</td> <td>Replace Cutting head ARC &amp; ARC TE</td> <td>132,00€</td> </tr> </tbody> </table>	Referencia	DESCRIPCIÓN	Euros	ARCCH	Replace Cutting head ARC & ARC TE	132,00€
Referencia	DESCRIPCIÓN	Euros					
ARCCH	Replace Cutting head ARC & ARC TE	132,00€					
	<table border="1"> <thead> <tr> <th>Referencia</th> <th>DESCRIPCIÓN</th> <th>Euros</th> </tr> </thead> <tbody> <tr> <td>EVOTCS</td> <td>Textile cutting Strip 4,5m</td> <td>81,70€</td> </tr> </tbody> </table>	Referencia	DESCRIPCIÓN	Euros	EVOTCS	Textile cutting Strip 4,5m	81,70€
Referencia	DESCRIPCIÓN	Euros					
EVOTCS	Textile cutting Strip 4,5m	81,70€					
	<table border="1"> <thead> <tr> <th>Referencia</th> <th>DESCRIPCIÓN</th> <th>Euros</th> </tr> </thead> <tbody> <tr> <td>SILWR</td> <td>White round Silicone cord 10m</td> <td>99,2€</td> </tr> </tbody> </table>	Referencia	DESCRIPCIÓN	Euros	SILWR	White round Silicone cord 10m	99,2€
Referencia	DESCRIPCIÓN	Euros					
SILWR	White round Silicone cord 10m	99,2€					
	<table border="1"> <thead> <tr> <th>Referencia</th> <th>DESCRIPCIÓN</th> <th>Euros</th> </tr> </thead> <tbody> <tr> <td>CA75-115</td> <td>Linear Bearing (x2)</td> <td>17,5€</td> </tr> </tbody> </table>	Referencia	DESCRIPCIÓN	Euros	CA75-115	Linear Bearing (x2)	17,5€
Referencia	DESCRIPCIÓN	Euros					
CA75-115	Linear Bearing (x2)	17,5€					
	<table border="1"> <thead> <tr> <th>Referencia</th> <th>DESCRIPCIÓN</th> <th>Euros</th> </tr> </thead> <tbody> <tr> <td>HOT</td> <td>HSGM soporte corte textil caliente</td> <td>174€</td> </tr> </tbody> </table>	Referencia	DESCRIPCIÓN	Euros	HOT	HSGM soporte corte textil caliente	174€
Referencia	DESCRIPCIÓN	Euros					
HOT	HSGM soporte corte textil caliente	174€					
	<table border="1"> <thead> <tr> <th>Referencia</th> <th>DESCRIPCIÓN</th> <th>Euros</th> </tr> </thead> <tbody> <tr> <td>TEXC</td> <td>28mm. Textile cutting tool (Sabre 2)</td> <td>51,80€</td> </tr> </tbody> </table>	Referencia	DESCRIPCIÓN	Euros	TEXC	28mm. Textile cutting tool (Sabre 2)	51,80€
Referencia	DESCRIPCIÓN	Euros					
TEXC	28mm. Textile cutting tool (Sabre 2)	51,80€					